

EASY GLASS® SLIM - Base shoe, fascia mount

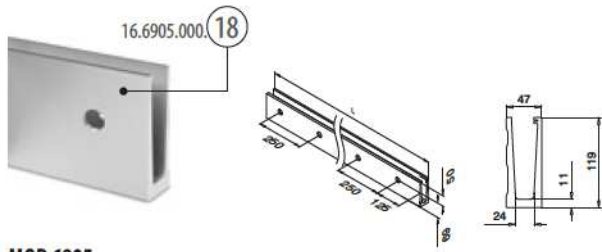

MOD 6905

Aluminium Stainless steel effect

OUTDOOR

16.6905.500.18 QS-519 341 L = 5000 mm

AbP NEN 2608 NEN 6702 CSTB ferro plan LGAM Typen geprüft BS 6180

Safety Wedge System:
Glass is being clamped. Drilling is not necessary.

Accessories

EASY GLASS® - Multitool



MOD 6920

Accessories		
	Q	
19.6920.000.00	Q-71	1

International Design Model Protection



MOD 6904

Accessories		
	T	
19.6904.912.00	12	L = 5000 mm
19.6904.913.00	12,76 (6 - 0,76 - 6)	L = 5000 mm
19.6904.914.00	13,52 (6 - 1,52 - 6)	L = 5000 mm
19.6904.915.00	15	L = 5000 mm
19.6904.917.00	16,76 (8 - 0,76 - 8)	L = 5000 mm
19.6904.918.00	17,52 (8 - 1,52 - 8)	L = 5000 mm
19.6904.919.00	19	L = 5000 mm
19.6904.921.00	20,76 (10 - 0,76 - 10)	L = 5000 mm
19.6904.922.00	21,52 (10 - 1,52 - 10)	L = 5000 mm
19.6904.512.00	12	L = 25 m
19.6904.513.00	12,76 (6 - 0,76 - 6)	L = 25 m
19.6904.514.00	13,52 (6 - 1,52 - 6)	L = 25 m
19.6904.515.00	15	L = 25 m
19.6904.517.00	16,76 (8 - 0,76 - 8)	L = 25 m
19.6904.518.00	17,52 (8 - 1,52 - 8)	L = 25 m
19.6904.519.00	19	L = 25 m
19.6904.521.00	20,76 (10 - 0,76 - 10)	L = 25 m
19.6904.522.00	21,52 (10 - 1,52 - 10)	L = 25 m

Q-INFO

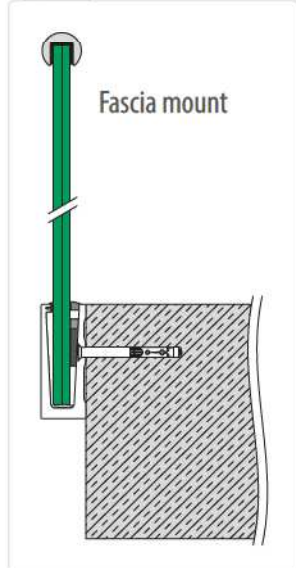

Q-INFO MOD 6905

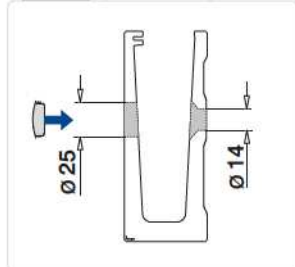

Q-INFO MOD 6905

We can cut this article for you based on your specifications for length and required angles. Contact us for details, or see the 'Cutting' information on page 379-381, 383.

Q-INFO MOD 6920



Q-INFO MOD 6905

Possible applications
Fascia mounting

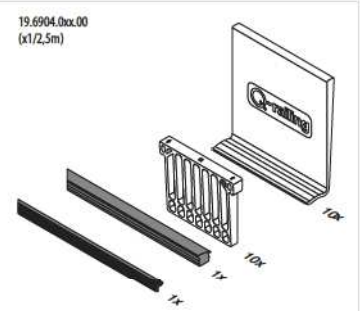
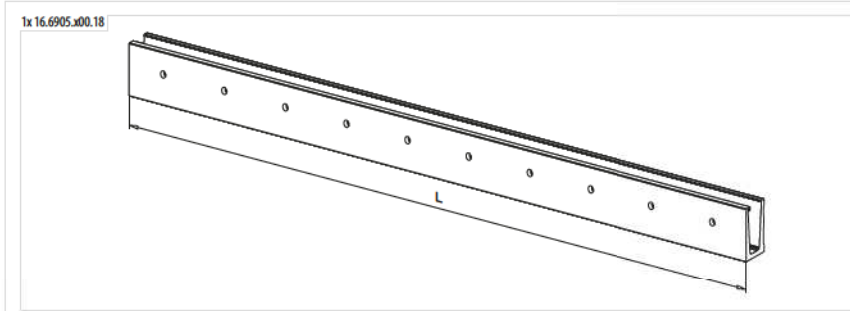
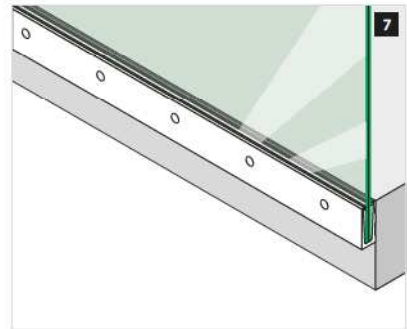
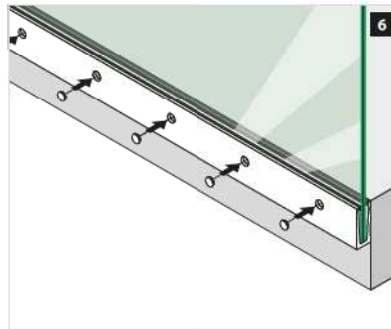
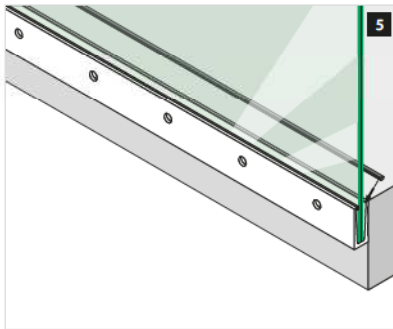
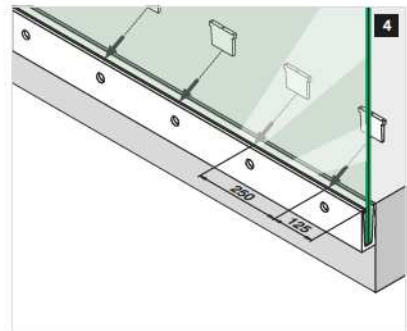
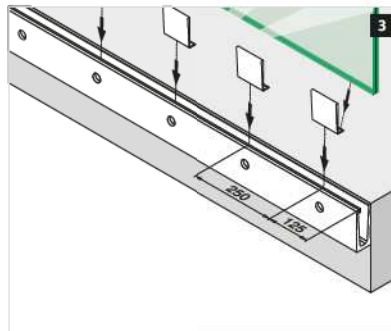
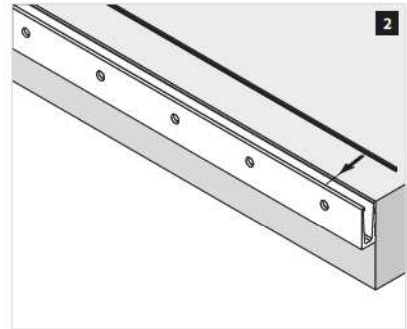
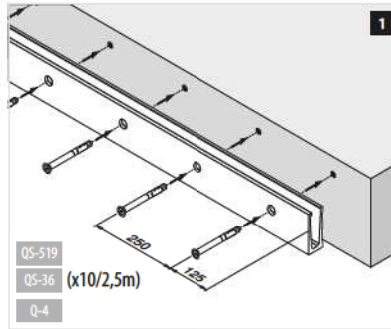
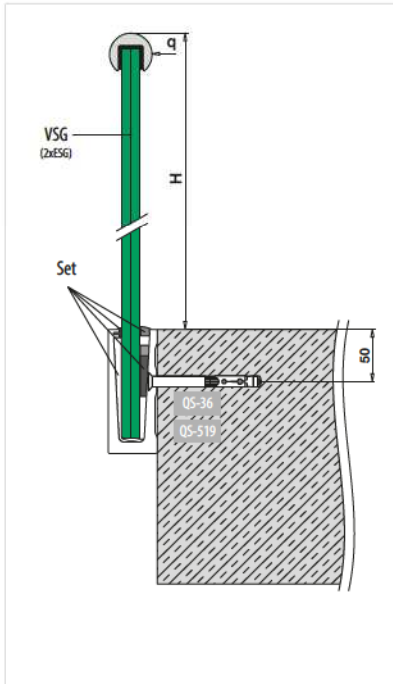

VSG (2x ESG): Laminated glass from toughened glass
ESG : Toughened glass

Please note for specifications such as mounting and glass dimension measurements, see the respective certificates.

For more information, please visit our website:
www.q-railing.com



Q-INFO MOD 6921

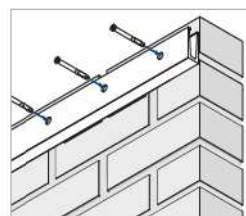
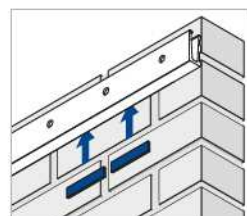

EASY GLASS® SLIM - Connectors, fascia mount

Inner corner

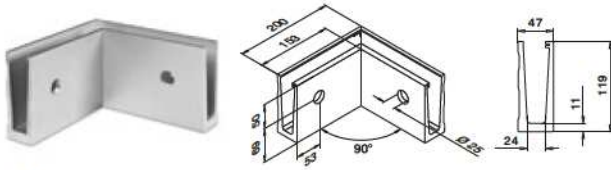

MOD 6315

Aluminium	Stainless steel effect
OUTDOOR	
16.6315.005.18	QS-36 341 / QS-519 341
	1



Outer corner

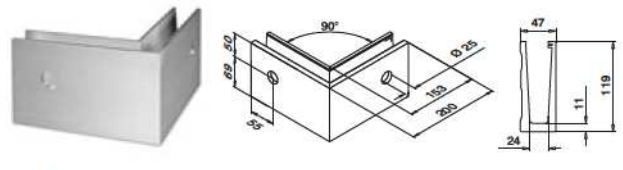

MOD 6316

Aluminium	Stainless steel effect
OUTDOOR	
16.6316.005.18	QS-520 339 / QS-521 339
	1



EASY GLASS® SLIM - Cladding, fascia mount

Cladding frontside



MOD 6920

304	
INDOOR	L = 2500 mm
13.6920.005.12	
316	
OUTDOOR	L = 5000 mm
14.6920.505.12	



Cladding frontside



MOD 6920

Aluminium	Stainless steel effect
OUTDOOR	
16.6920.005.18	L = 2500 mm

EASY GLASS® SLIM - Blind plugs for fascia mounting



MOD 6922

ABS plastic	
OUTDOOR	
24.6922.007.36	10

Q-INFO MOD 6315 / 6316

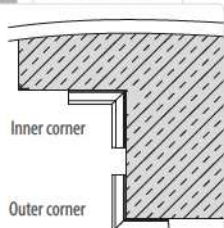

Q-INFO MOD 6922

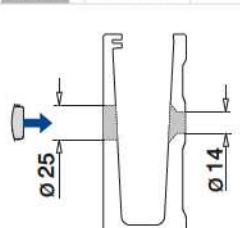

EASY GLASS® SLIM - End fittings, fascia mount - use with cladding

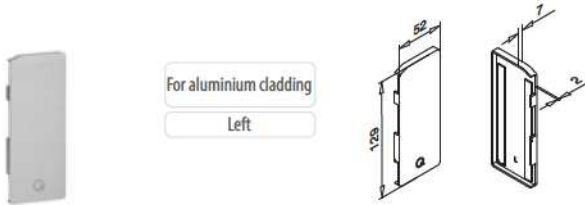

MOD 6734

Aluminium	Stainless steel effect
OUTDOOR	
16.6734.105.18	1

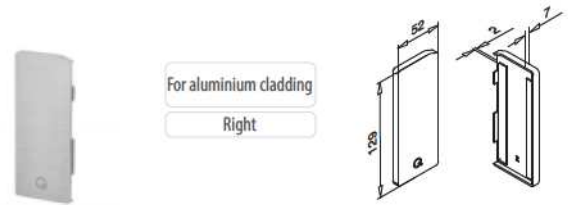

MOD 6735

Aluminium	Stainless steel effect
OUTDOOR	
16.6735.105.18	1

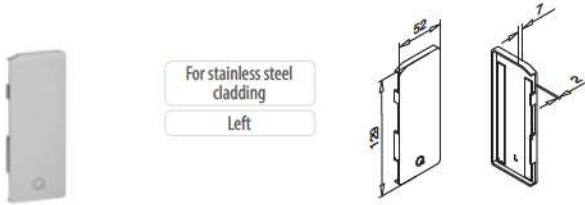

MOD 6734

Zinc	Stainless steel effect
OUTDOOR	
10.6734.105.20	1

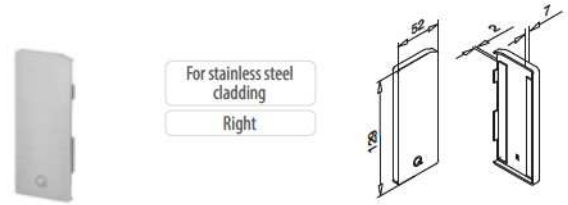

MOD 6735

Zinc	Stainless steel effect
OUTDOOR	
10.6735.105.20	1

Q-INFO MOD 6734 / 6735

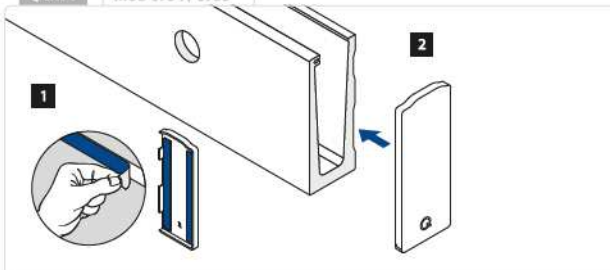

EASY GLASS® SLIM - End fittings, fascia mount - use without cladding

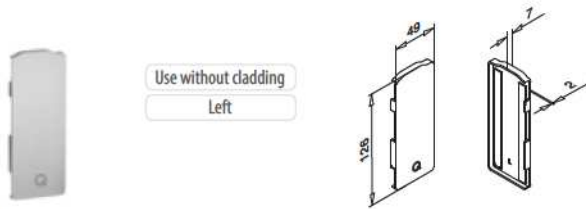

Use without cladding
Left

MOD 6734

Aluminium	Stainless steel effect
OUTDOOR	
16.6734.005.18	1

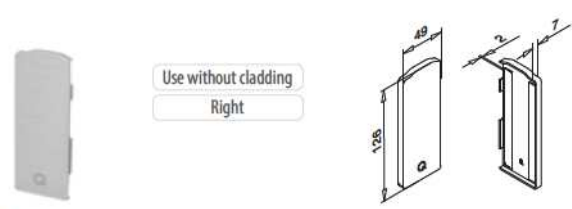

Use without cladding
Right

MOD 6735

Aluminium	Stainless steel effect
OUTDOOR	
16.6735.005.18	1

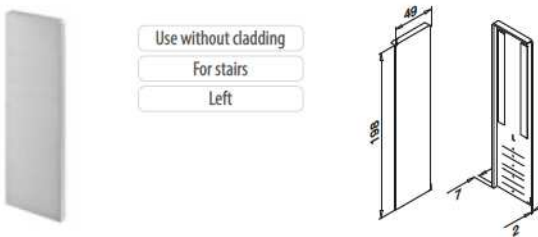

Use without cladding
For stairs
Left

MOD 6736

Aluminium	Stainless steel effect
OUTDOOR	
16.6736.005.18	1

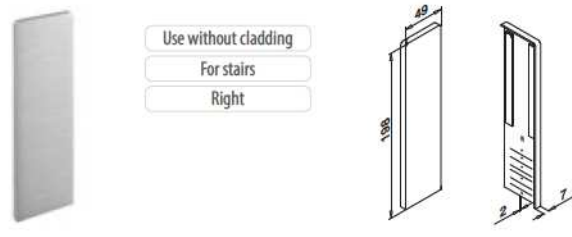

Use without cladding
For stairs
Right

MOD 6737

Aluminium	Stainless steel effect
OUTDOOR	
16.6737.005.18	1



Q-INFO MOD 6734 / 6735

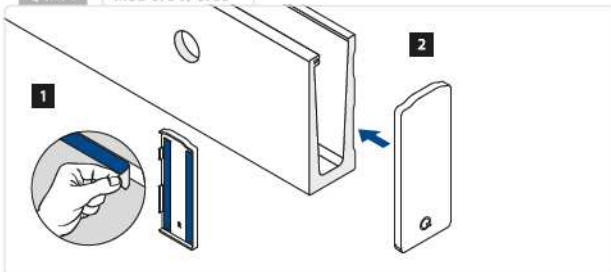

Q-INFO MOD 6736 / 6737

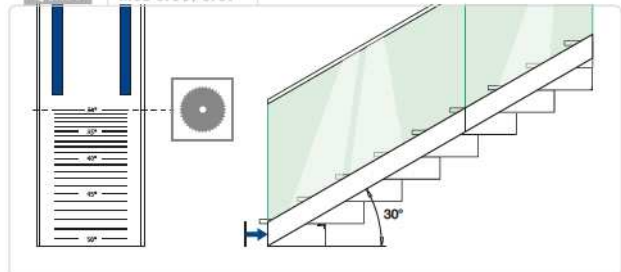

EASY GLASS® SLIM - Mounting plates, fascia mount

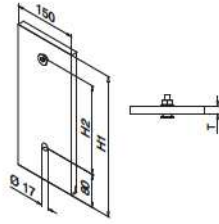

MOD 6951

Zinc-plated		H1	H2	T	
19.6951.250.15	QS-507 339	250	125	12	1
19.6951.340.15	QS-507 339	340	215	15	1

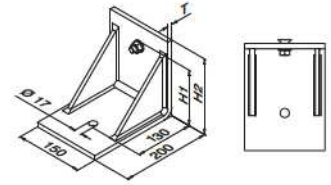

MOD 6952

Zinc-plated		H1	H2	T	
19.6952.120.15	QS-60 339 / QS-61 339	75	120	10	1
19.6952.170.15	QS-60 339 / QS-61 339	125	170	10	1

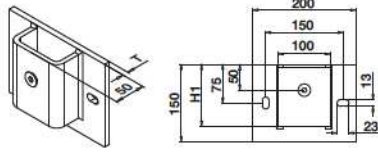

MOD 6953

Zinc-plated		H1	T	
19.6953.150.15	QS-60 339 / QS-61 339	120	10	1

Q-INFO MOD 6951 / 6952 / 6953

